

**Cerniere Serie Smart Clip-on  
con chiusura ammortizzata -  $\varnothing$  35  
Assemblaggio Clip-on**

Hinges range Smart Clip-on  
with soft-closing -  $\varnothing$  35  
Clip-on assembly

**Cerniera automatica - Clip-on - acciaio nichelato - con meccanismo chiusura ammortizzata**  
Automatic hinge - Clip-on - nickel plated steel - with soft-closing mechanism

## ANGOLI DI APERTURA OPENING ANGLES

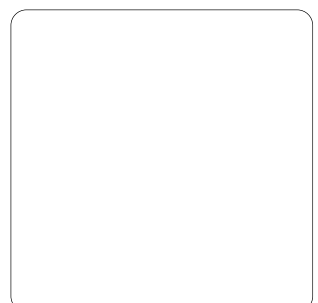
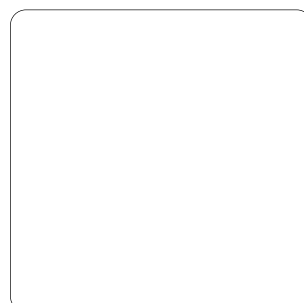
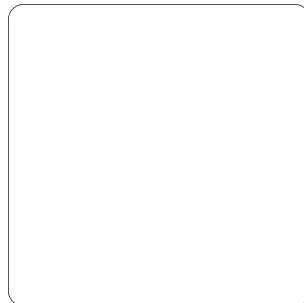
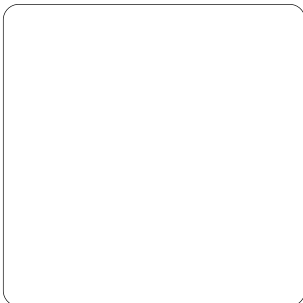
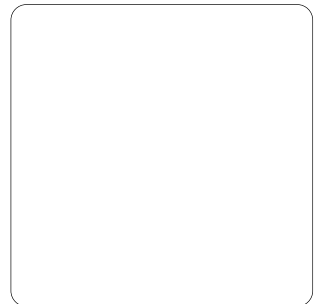
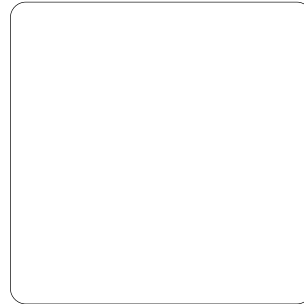
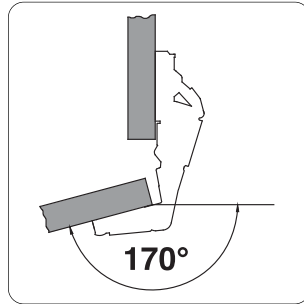
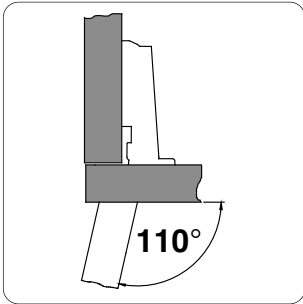

**Cerniera automatica - Clip-on - acciaio nichelato - con chiusura ammortizzata**  
 Automatic hinge - Clip-on - nickel plated steel - soft-closing

**TM SMART  
 SOFT-CLOSING 110°**

**Collo "0"**  
 Sormonto fino 21 mm.  
**Cranking "0"**  
 Full overlay application

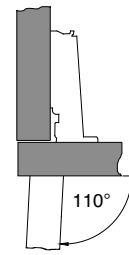

<b>Avvitare</b> Screw-on 		<b>C54A476.10</b>	
<b>Pressione</b> Knock-in 		<b>C54A476M.10</b>	
<b>Euro Viti</b> Euro screws 			
<b>FAST SYSTEM</b> 			

**TM SMART  
 SOFT-CLOSING 110°**

**Collo "9"**  
 Sormonto fino 12 mm.  
**Cranking "9"**  
 Half overlay application

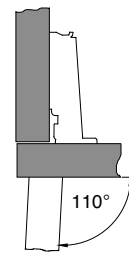

<b>Avvitare</b> Screw-on 		<b>C54B476.10</b>	
<b>Pressione</b> Knock-in 		<b>C54B476M.10</b>	
<b>Euro Viti</b> Euro screws 			
<b>FAST SYSTEM</b> 			

**Cerniera automatica - Clip-on - acciaio nichelato - con chiusura ammortizzata**  
 Automatic hinge - Clip-on - nickel plated steel - soft-closing

**TM SMART  
 SOFT-CLOSING 110°**

Collo "18"  
 Per ante interne  
 Cranking "18"  
 Insert application

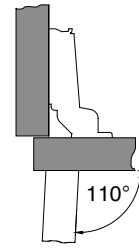

<b>Avvitare</b> Screw-on		<b>C54C476.10</b>	
<b>Pressione</b> Knock-in		<b>C54C476M.10</b>	
<b>Euro Viti</b> Euro screws			
<b>FAST SYSTEM</b>			

**TM SMART  
 SOFT-CLOSING 170°**



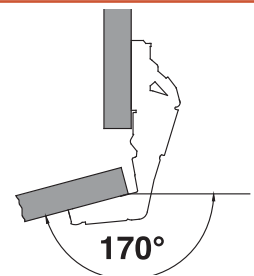





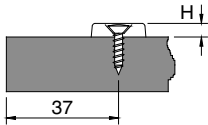

Per ante con grande angolo di apertura  
 For wide angle-opening doors

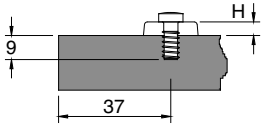

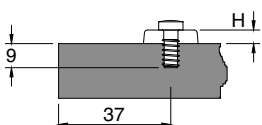
<b>Avvitare</b> Screw-on		<b>C54A506.10</b>	
<b>Pressione</b> Knock-in		<b>C54A506M.10</b>	
<b>Euro Viti</b> Euro screws			
<b>FAST SYSTEM</b>			

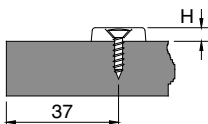
## Basette di montaggio per cerniere TM SMART Soft-closing

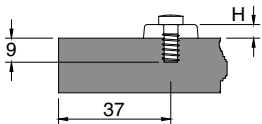
### Mounting paltes for TM SMART Soft-closing

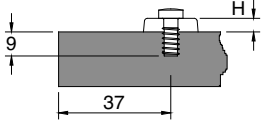
Base in acciaio nichelato con fissaggio a vite - Mounting plate steel nikel plated, screw fixing			
		<b>H</b>	<b>Codice Code</b>
		0 mm	<b>B00QMS.10</b>
		2 mm	<b>B20QMS.10</b>
Base in acciaio nichelato con fissaggio a vite EURO 12 mm - Mounting plate steel nikel plated, 12 mm EURO screw fixing			
		<b>H</b>	<b>Codice Code</b>
		0 mm	<b>B06QMS.10</b>
		2 mm	<b>B26QMS.10</b>
Base in acciaio nichelato con fissaggio a vite EURO 14 mm - Mounting plate steel nikel plated, 14 mm EURO screw fixing			
		<b>H</b>	<b>Codice Code</b>
		0 mm	<b>B02QMS.10</b>
		2 mm	<b>B22QMS.10</b>
Base in acciaio nichelato con fissaggio a vite e regolazione 3D - Mounting plate steel nikel plated, screw fixing and 3D adjustment screw			
		<b>H</b>	<b>Codice Code</b>
		0 mm	<b>B00TMS.10</b>
		2 mm	<b>B20TMS.10</b>
Base in acciaio nichelato con fissaggio a vite EURO 12 mm e regolazione 3D - Mounting plate steel nikel plated, 12 mm EURO screw fixing and 3D adjustment screw			
		<b>H</b>	<b>Codice Code</b>
		0 mm	<b>B06TMS.10</b>
		2 mm	<b>B26TMS.10</b>
Base in acciaio nichelato con fissaggio a vite EURO 14 mm e regolazione 3D - Mounting plate steel nikel plated, 14 mm EURO screw fixing and 3D adjustment screw			
		<b>H</b>	<b>Codice Code</b>
		0 mm	<b>B02TMS.10</b>
		2 mm	<b>B22TMS.10</b>

**Note**

Note

**Tabella  
Soft-Closing  
110°  
collo dritto**

 Drilling  
distance **C**  
(mm)

<b>D - Sormonto Porta</b> Door overlay (mm)	<b>K - Distanza scatola cerniera / Hinges box distance (mm)</b>							
	<b>3</b>	<b>4</b>	<b>5</b>	<b>6</b>	<b>7</b>			
<b>21,0</b>					0			
<b>21,0</b>				0				
<b>19,0</b>			0		2			
<b>18,0</b>		0		2				
<b>17,0</b>	0		2		4			
<b>16,0</b>		2		4				
<b>15,0</b>	2		4					
<b>14,0</b>		4						
<b>13,0</b>	4							

**H - Altezza base di Fissaggio / Mounting plate height (mm)**
**Tabella  
Soft-Closing  
110°  
collo medio**

 Drilling  
distance **C**  
(mm)

<b>D - Sormonto Porta</b> Door overlay (mm)	<b>K - Distanza scatola cerniera / Hinges box distance (mm)</b>							
	<b>3</b>	<b>4</b>	<b>5</b>	<b>6</b>	<b>7</b>			
<b>11,0</b>					0			
<b>10,0</b>				0				
<b>9,0</b>			0		2			
<b>8,0</b>		0		2				
<b>7,0</b>	0		2		4			
<b>6,0</b>		2		4				
<b>5,0</b>	2		4					
<b>4,0</b>		4						
<b>3,0</b>	4							

**H - Altezza base di Fissaggio / Mounting plate height (mm)**
**Tabella  
Soft-Closing  
110°  
collo alto**

 Drilling  
distance **C**  
(mm)

<b>D - Sormonto Porta</b> Door overlay (mm)	<b>K - Distanza scatola cerniera / Hinges box distance (mm)</b>							
	<b>3</b>	<b>4</b>	<b>5</b>	<b>6</b>	<b>7</b>			
<b>-3,0</b>					0			
<b>-2,0</b>				0				
<b>-1,0</b>			0		2			
<b>0,0</b>		0		2				
<b>1,0</b>	0		2		4			
<b>2,0</b>		2		4				
<b>3,0</b>	2		4					
<b>4,0</b>		4						
<b>5,0</b>	4							

**H - Altezza base di Fissaggio / Mounting plate height (mm)**
**Tabella  
Soft-Closing  
170°**

 Drilling  
distance **C**  
(mm)

<b>D - Sormonto Porta</b> Door overlay (mm)	<b>K - Distanza scatola cerniera / Hinges box distance (mm)</b>							
	<b>3</b>	<b>4</b>	<b>5</b>	<b>6</b>	<b>7</b>			
<b>21,0</b>					0			
<b>20,0</b>				0				
<b>19,0</b>			0		2			
<b>18,0</b>		0		2				
<b>17,0</b>	0		2		4			
<b>16,0</b>		2		4				
<b>15,0</b>	2		4					
<b>14,0</b>		4						
<b>13,0</b>	4							

**H - Altezza base di Fissaggio / Mounting plate height (mm)**