

Accessori
Accessories

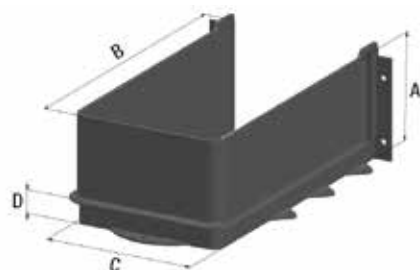
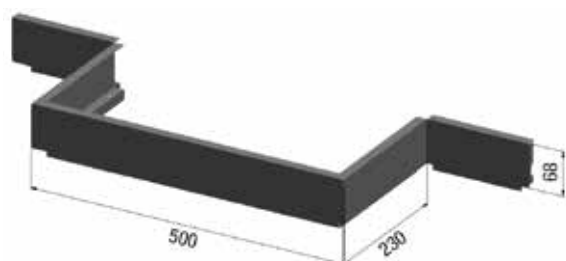
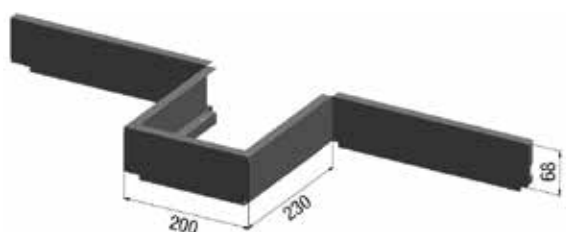

Retro in metallo / Straight metal back panel

Codice <i>Code</i>	Finitura sponda/ <i>Slim box finishing</i>			Modulo <i>Module</i>	Interno mobile <i>Cabinet Inner</i>
	GA	GC	B		
RC45-SL84 -				450	414
RC60-SL84 -				600	564
RC90-SL84 -				900	864
RC120-SL84 -				1200	1164

Retro in metallo sagomato per lavello ad uno scarico (bagno)

U-shaped metal back panel for single drain sink (bathroom)

Codice <i>Code</i>	Finitura sponda/ <i>Slim box finishing</i>			Modulo <i>Module</i>	Interno mobile <i>Cabinet Inner</i>
	GA	GC	B		
RC60-20-SL84 -				600	564
RC90-20-SL84 -				900	864
RC120-20-SL84 -				1200	1164

Retro in metallo sagomato per lavello a due scarichi (cucina)

U-shaped metal back panel for double drain sink (kitchen)

Codice <i>Code</i>	Finitura sponda/ <i>Slim box finishing</i>			Modulo <i>Module</i>	Interno mobile <i>Cabinet Inner</i>
	GA	GC	B		
RC60-50-SL84 -				600	564
RC90-50-SL84 -				900	864
RC120-50-SL84 -				1200	1164

Retro in plastica a U per lavello ad uno scarico (bagno)

U-shaped plastic back panel for single drain sink (bathroom)

Codice / <i>Code</i>	A	B	C	D
RC-PLAST-Q -	84	230	120	16

Accessori
Accessories

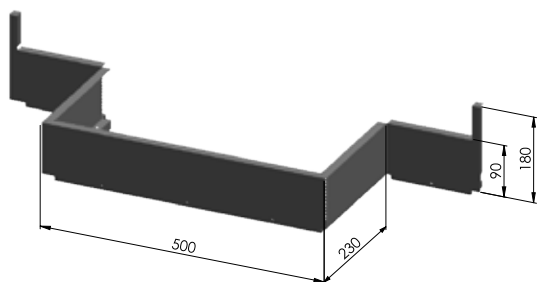

Retro in metallo / Straight metal back panel					
Codice	Finitura sponda/Slim box finishing			Modulo	Interno mobile
Code	GA	GC	B	Module	Cabinet Inner
RC90-50-SL199/90-				900	864

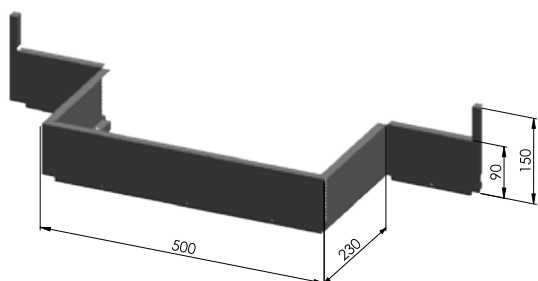

Retro in metallo / Straight metal back panel					
Codice	Finitura sponda/Slim box finishing			Modulo	Interno mobile
Code	GA	GC	B	Module	Cabinet Inner
RC90-50-SL167/90-				900	864

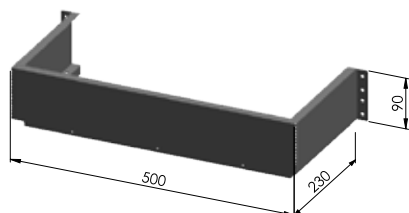

Retro in metallo / Straight metal back panel					
Codice	Finitura sponda/Slim box finishing			Modulo	Interno mobile
Code	GA	GC	B	Module	Cabinet Inner
RC-L-00-50-H9				-	-

Kit frontale per cassetto interno

Inner drawer front panel kit

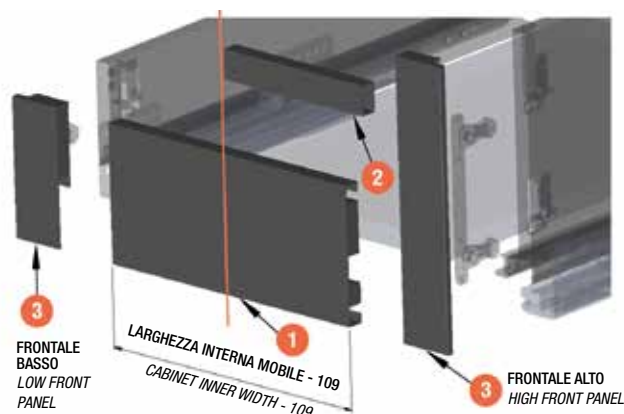

Componenti	Components
1 Frontale in metallo	Metal Front Panel
2 Ringhierina in metallo/	Metal Railing
3 Supporto frontale in metallo	Front Panel Metal Support

Codice	Finitura sponda/Slim box finishing	Finitura sponda/Slim box finishing			L
		GA	GC	B	
1 SP-SL-FRONT 600 -					600 mm
1 SP-SL-FRONT 1200 -					1200 mm
2 SP-SL-RAIL 600 -					600 mm
2 SP-SL-RAIL 1200 -					1200 mm

Codice	Finitura sponda/Slim box finishing	Finitura sponda/Slim box finishing			H
		GA	GC	B	
3 SP-SL-SUPANT 84 -					84
3 SP-SL-SUPANT 116 -					116
3 SP-SL-SUPANT 167 -					167
3 SP-SL-SUPANT 199 -					199

Supporti retro in legno

Wooden back panel supports



Codice	Finitura sponda/Slim box finishing	Finitura sponda/Slim box finishing			H
		GA	GC	B	
SP-SL-SUP 84 -					84
SP-SL-SUP 116 -					116
SP-SL-SUP 167 -					167
SP-SL-SUP 199 -					199

Ringhierina per cassetto

Railing for large drawer



Codice	Finitura sponda/Slim box finishing	Finitura sponda/Slim box finishing			L
		GA	GC	B	
SP-SL-RAIL 30 -					300
SP-SL-RAIL 35 -					350
SP-SL-RAIL 40 -					400
SP-SL-RAIL 45 -					450
SP-SL-RAIL 50 -					500
SP-SL-RAIL 55 -					550